

# CHAIN BREAKER MANUAL

DESIGNED FOR DISASSEMBLING SINGLE STRAND TSUBAKI ROLLER CHAINS

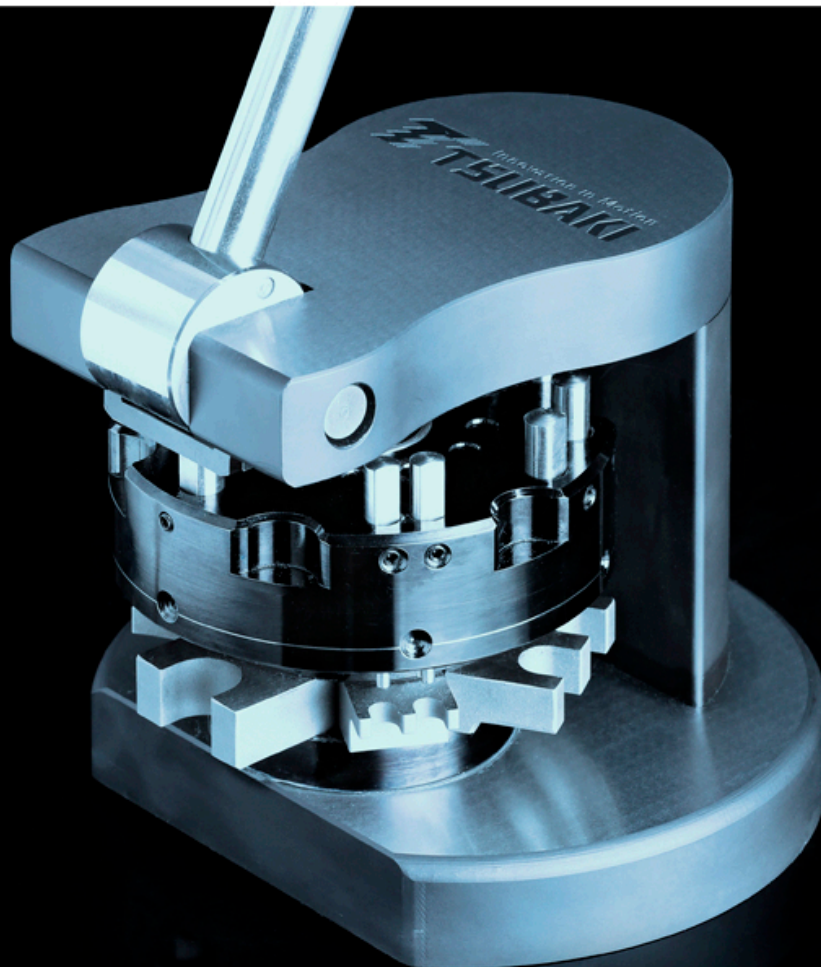

# Table of contents:

1. Tool box content	3
2. Range of operation	4
3. How to install the Tsubaki Chain Breaker	5
4. Maintenance Instruction	7
5. Replacing Tooling parts	
5.1 Replacement of cutting pins	9
5.2 Replacement of chain guide	11
6. Chain cutting instruction	13
7. Warranty	16

# 1. Tool box content

## Tool set

- Chain breaker
- RS35 Chain guide
- Punch

## Assembly set

- Attachment mat
- Mounting set short (M10) Incl. Threaded end, hammer head nut, standard nut, washer (3 pcs each)
- Mounting set long (M10): 3 pcs x 500 mm, to apply for assembly on workbench with large thickness

## Documents

- Manual (English version)

## 2. Range of operation

The Tsubaki chain breaker is designed for disassembling single strand Tsubaki roller chains.

### Standard range of operation:

#### - Standard Tsubaki chain series

- European sizes RS05B to RS16B
- ANSI sizes RS35\* to RS80

#### - Tsubaki heavy duty series

- RS80-SUP-1 Heavy Duty Chain

#### - Tsubaki motorcycle gamma chain series (non sealed)

- 428 Gamma
- 530 Gamma

\*For cutting RS35-1 Chain it is needed to use the appropriate chain guide. Please check Chapter 5.2 for replacement instruction.

### Note:

It is required that the tool is operated by a skilled worker.

### 3. How to install the Tsubaki chain breaker

- 1) Drill holes for attaching the tool into the bench through the attachment mat.

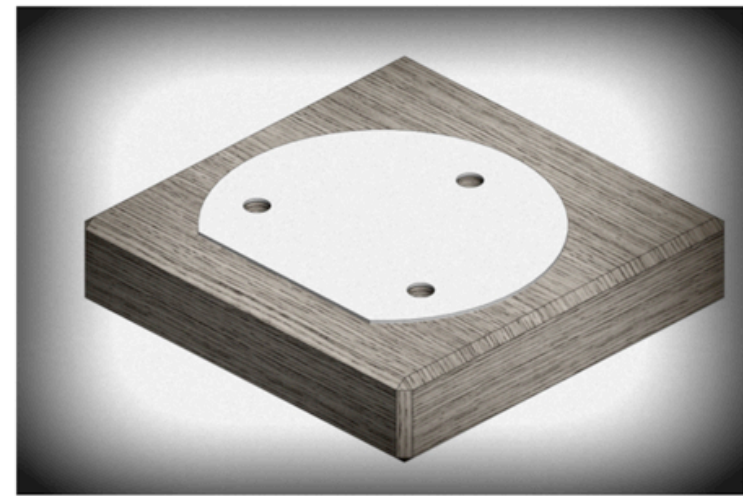

- 2) Insert the chain guide into the groove on the bottom part of the tool all the way to the end.



3) With help of screws ('Mounting set short'), attach the tool to the bench. The screws are screwed into the chain guide inserted in the bottom part of the tool. In case of workbenches with increased bench thickness, it is possible to apply the longer threaded bolts ('Mounting set long') and cut the bolts to suitable length.

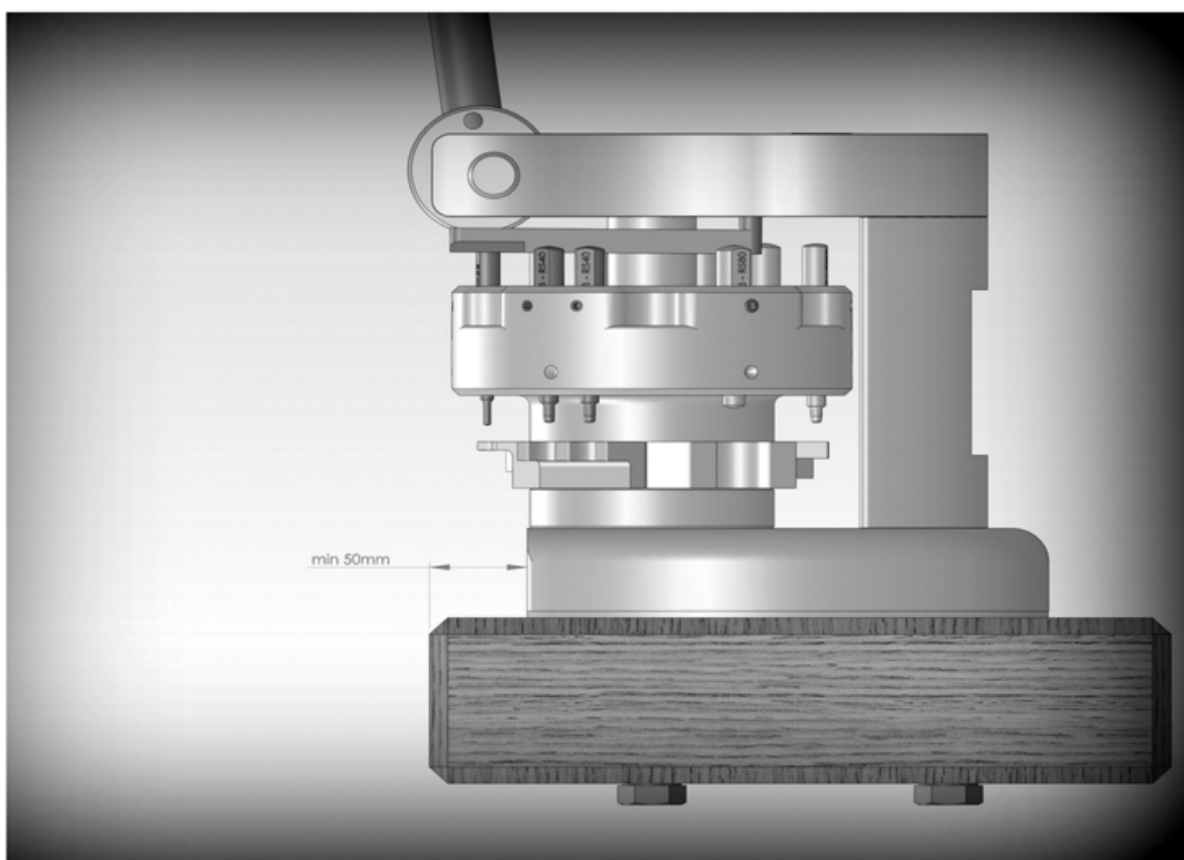
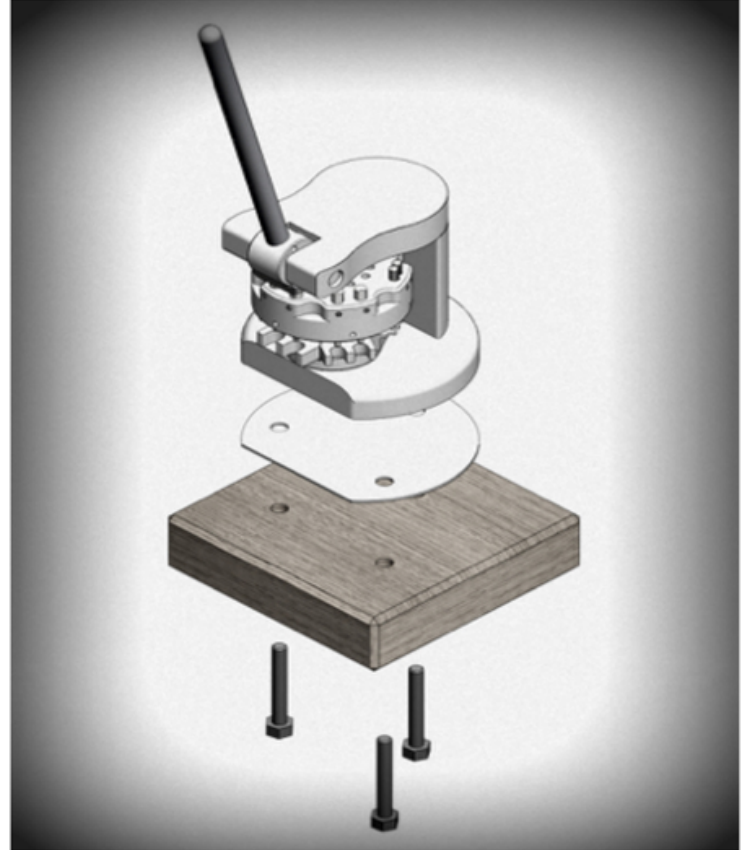
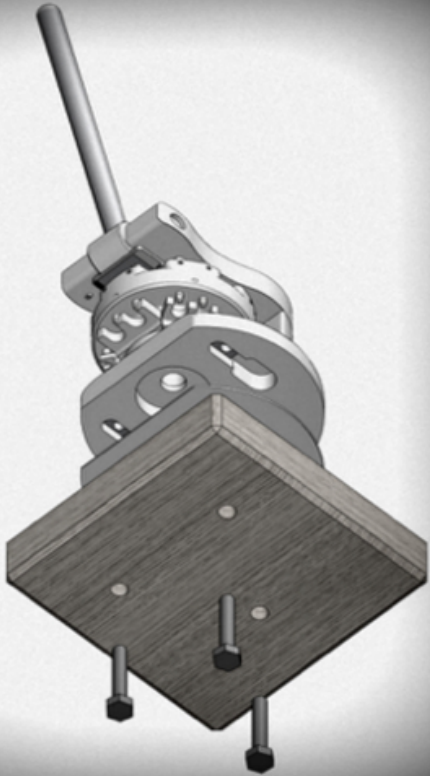



## 4. Maintenance instruction

The equipment is made from high quality heat-treated material to ensure a long life of the device, as well as worker's safety.

**Please follow these rules:**

- 1) Make sure that the marked points as below are always lubricated. In this way you will ensure a long life of the tool and easy operation.

Grease point



Grease point

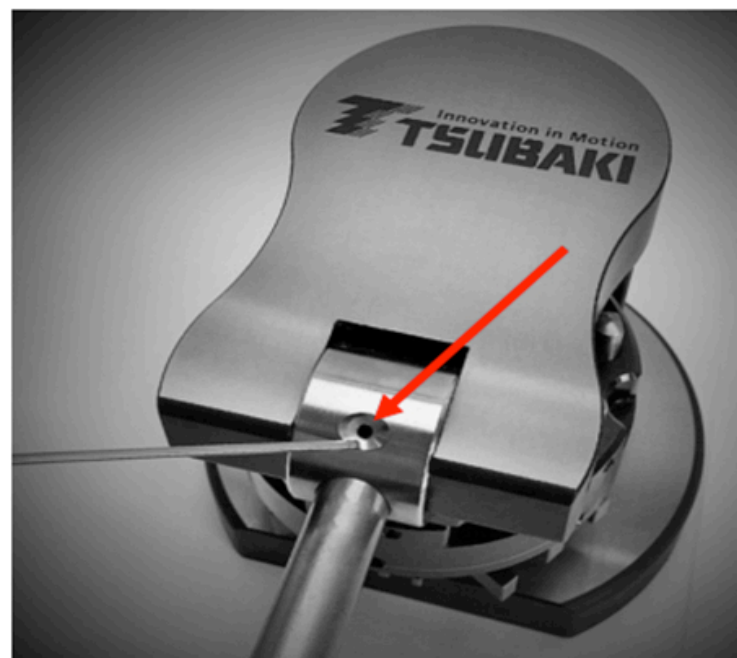

- 2) Never work with a damaged tool. Before you start work, always check the position and placement of the parts.

Correct position

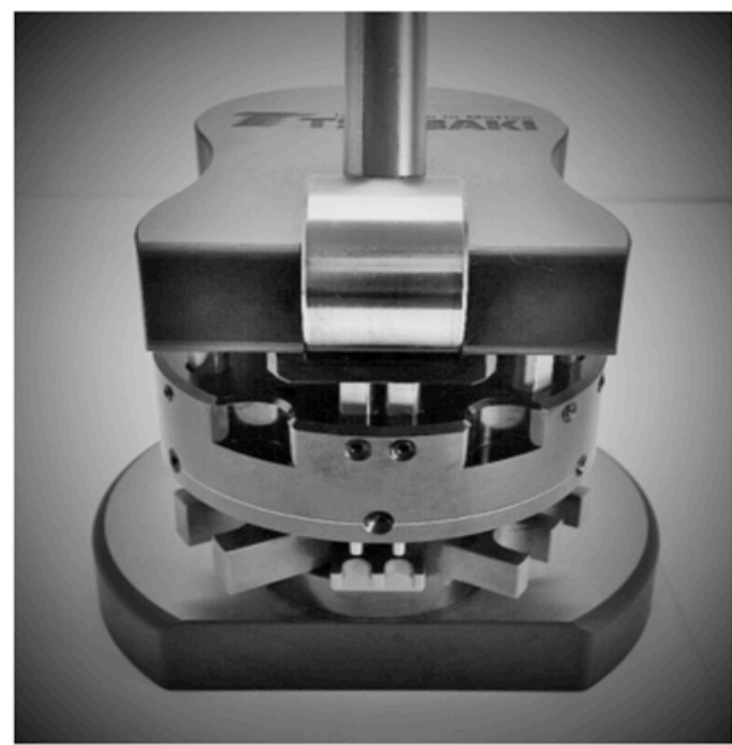

Not correct position

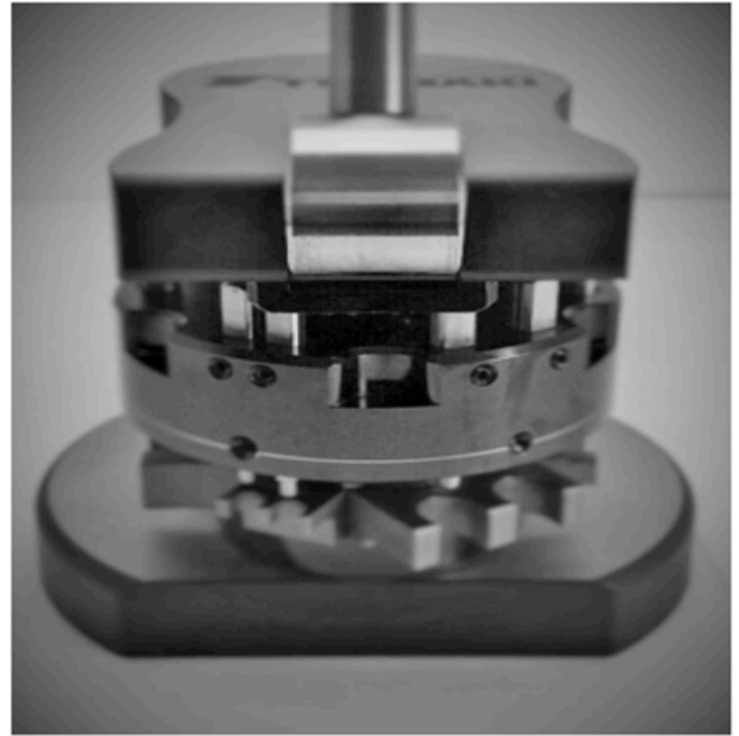

- 3) The tool must be firmly attached to the working bench. After the work is finished, always clean and preserve the device. In this way you will protect your investment in this tool.

Our intention when designing it was to offer you a tool which can serve you for a long time to your full satisfaction.



## 5. Replacing tooling parts

### 5.1 Replacement of cutting pins

1) First unscrew the socket screw.

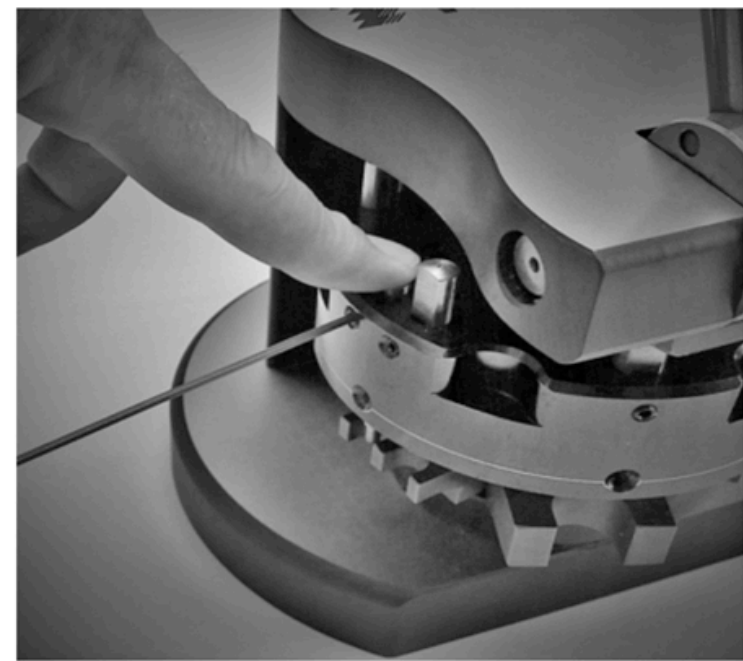

2) Then pull the cutting pin up from spring.



3) Pull the cutting pin up and return the spring to the hole.

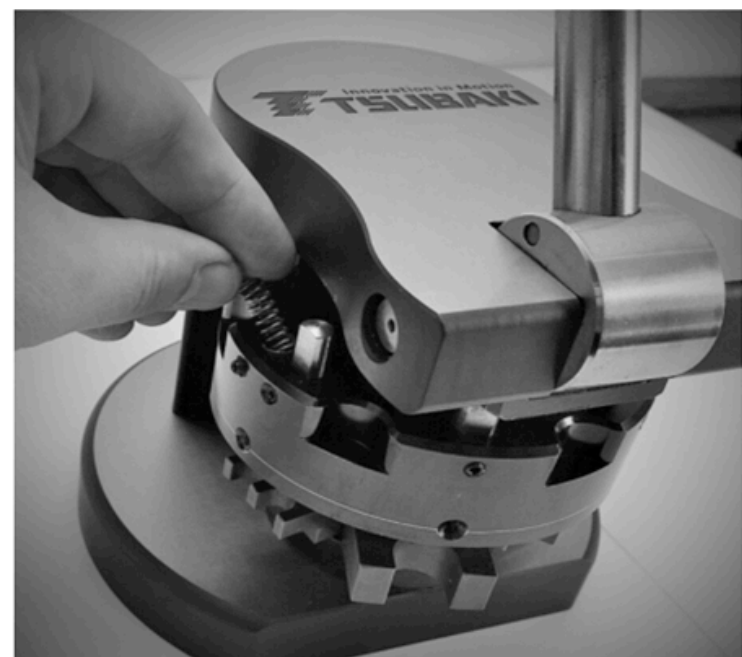

4) Turn the screw gently so that the cutting pin can be freely pressed down by a finger. Check if the cutting pin can move freely up and down. Adjust the screw until you reach a free movement of the cutting pin and at the same time ensure that it cannot be pulled up.

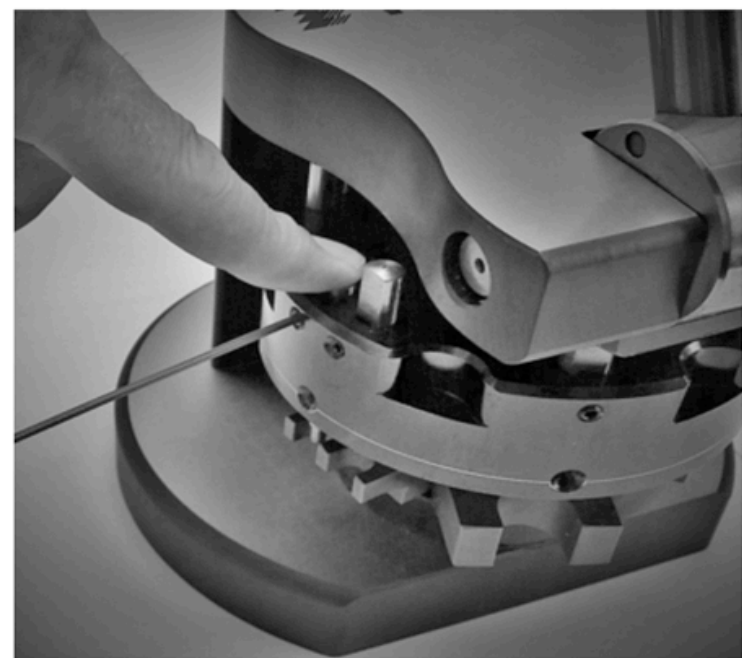

Follow the same procedure for replacement of the next cutting pin.

## 5.2 Replacement of chain guide

- 1) Disassemble the chain breaker.
- 2) By using the punch (included in the set) push out the press fit fixing pins.



3) Take out the chain guide and replace it by a new chain guide.



4) Press fit the fixing pins back (you can re-use the fixing pins).



5) Assemble the chain breaker again.

## 6. Chain cutting instruction

- 1) When operating the tool always wear safety goggles and apply applicable safety measures by local law.



- 2) First check that the tool is firmly attached to the bench. The equipment must be well fastened to the bench to withstand the forces of reaction that you have to overcome to press the cutting pin into the chain plate.

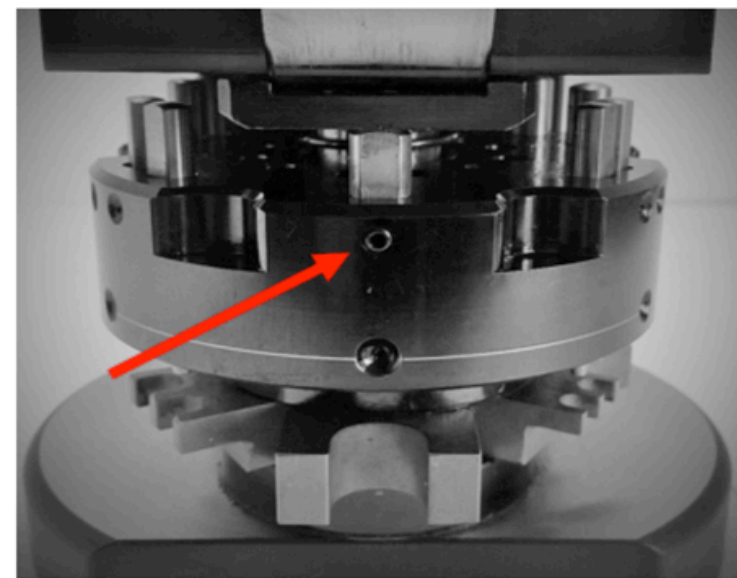

Adjust the screw until you reach a free movement of the cutting pin and at the same time ensure that it cannot be pulled up.

- 3) Please pay attention to the riveting style of the chain.

- Center sink riveted Tsubaki chains (Tsubaki Easy Break) do not need to be grinded before cutting the chain.
- For double stake and quad stake riveted chains we recommend grinding the riveted pin heads with an angle grinder (preferably NOT with a bench grinder).



Please follow below instruction:

- Center Sink rivet: No grinding needed.

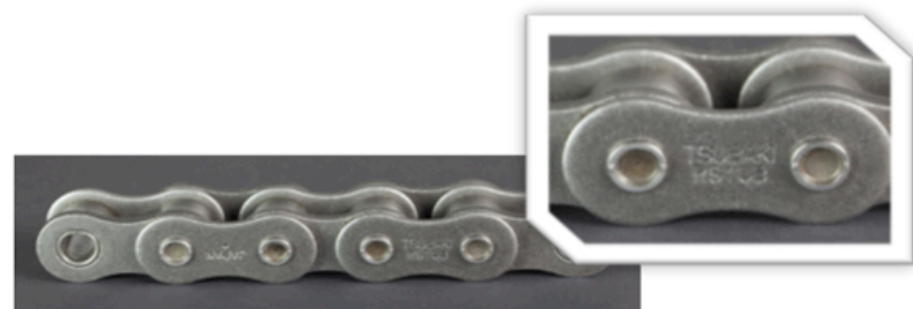

- Double stake rivet: Apply grinding.



- Quad stake rivet: Apply grinding.



- 4) Set the carousel under the lever to the required chain dimensions. Place the chain at the point where you want to extract the pins with the corresponding chain dimensions.





- 5) Make sure that the pins of the chain breaker are are directed at the centre of the chain pins. By using continuous pressure, without shocks, push pins out of the chain by using the lever. Put the lever back into its original position, remove and disassemble the chain.

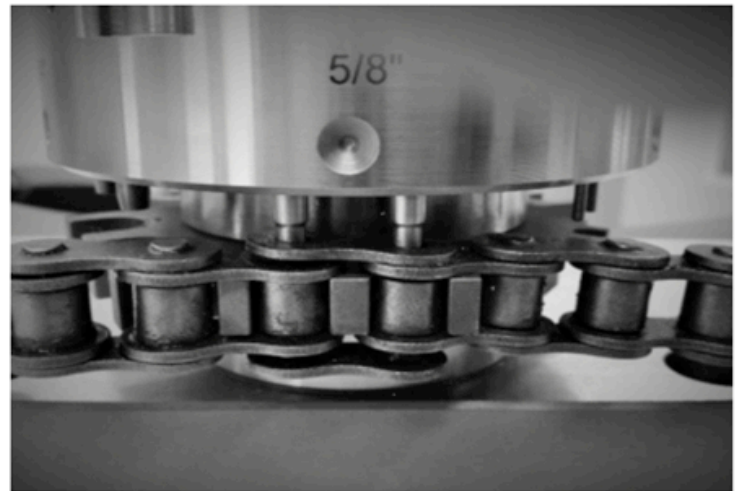
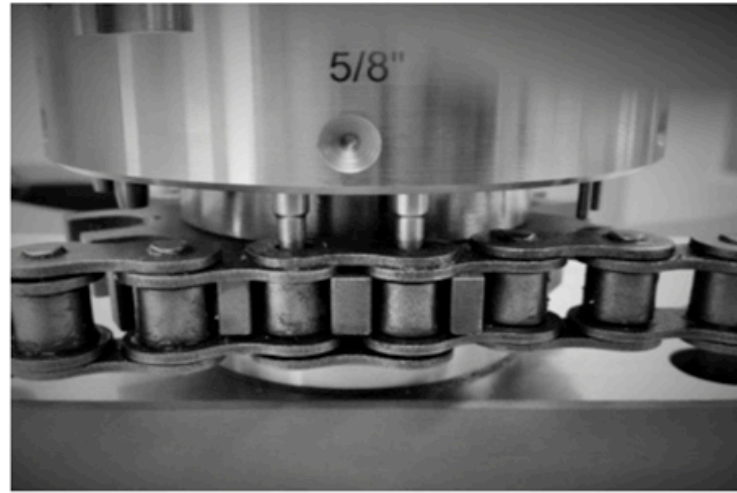
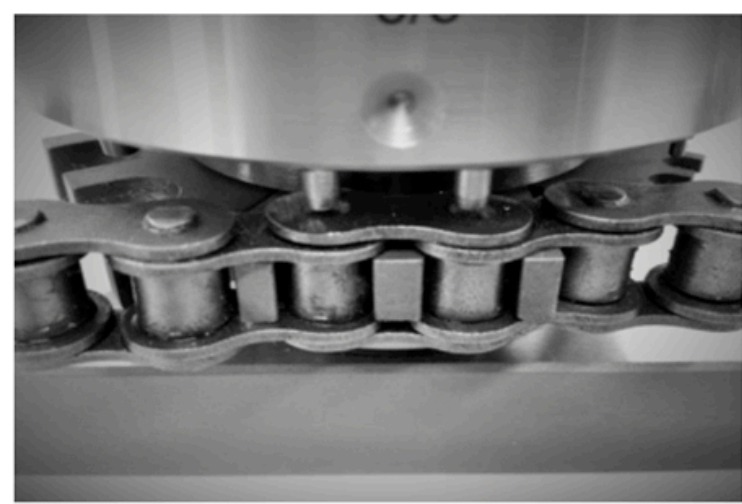

## 7. Warranty

This product is subject to Tsubakimoto Europe's General Terms and Conditions of Sale.

**Tsubakimoto Europe B.V.**  
Aventurijn 1200  
3316 LB Dordrecht  
The Netherlands  
Tel: +31 (0)78 620 4000  
E-mail: info@tsubaki.eu  
Internet: tsubaki.eu

**Tsubakimoto UK Ltd.**  
Osier Drive, Sherwood Park  
Annesley, Nottingham NG15 0DX  
United Kingdom  
Tel: +44 (0)1623 688 700  
E-mail: sales@tsubaki.co.uk  
Internet: tsubaki.eu

**Tsubaki Deutschland GmbH**  
ASTO Park Oberpaffenhofen  
Friedrichshafener Straße 1  
D-82205, Gilching  
Germany  
Tel: +49 (0)8105 7307 100  
E-mail: antriebstechnik@tsubaki.de  
Internet: tsubaki.de

## INDIAN OCEAN RIM

Singapore	Tsubakimoto Singapore Pte. Ltd.	+65 6861-0422/3/4	<a href="http://tsubaki.sg/">http://tsubaki.sg/</a>
Australia	Tsubaki Australia Pty. Limited	+61 2-9704-2500	<a href="http://tsubaki.com.au/">http://tsubaki.com.au/</a>
India	Tsubaki India Power Transmission Private Limited	+91 73580-80060	<a href="http://tsubaki.in/">http://tsubaki.in/</a>
Indonesia	PT. Tsubaki Indonesia Trading	+62 21-571-4230/1	<a href="http://tsubakimoto.co.id/">http://tsubakimoto.co.id/</a>
Malaysia	Tsubaki Power Transmission (Malaysia) Sdn. Bhd.	+60 3-7859-8585	<a href="http://tsubaki.my/">http://tsubaki.my/</a>
New Zealand	Tsubaki Australia Pty. Limited - New Zealand Branch	+64 9 352-2085	<a href="http://tsubaki.com.au/">http://tsubaki.com.au/</a>
Philippines	Tsubakimoto Singapore Pte. Ltd. - Philippines Representative Office	+63 2-808-0067	<a href="http://tsubaki.ph/">http://tsubaki.ph/</a>
Thailand	Tsubakimoto (Thailand) Co., Ltd.	+66 2-262-0667/9	<a href="http://tsubaki.co.th/">http://tsubaki.co.th/</a>
Vietnam	Tsubakimoto Vietnam Co., Ltd.	+84 4-6274-1449	<a href="http://tsubaki.net.vn/">http://tsubaki.net.vn/</a>